

16TCFM3000_Tunturi Cardio Fit Mini Bike M30

Spare parts service document

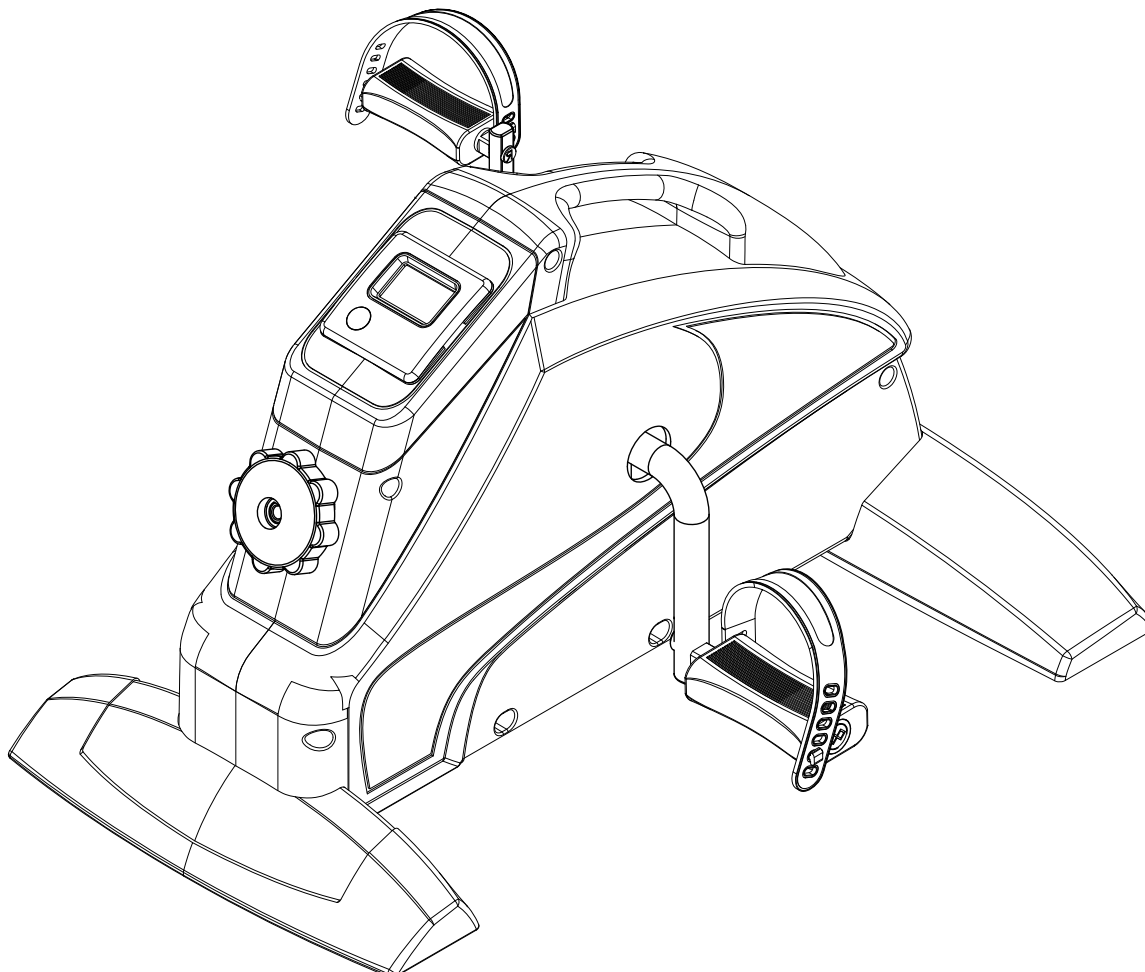

Extra document information

Document version : V. 1.0

Document release date : 20-11-2017

Valid for serialnumber range : 17G5AFN0001 - XXX

Serial shown as XXX means still in production on document change date



Tunturi New Fitness BV

Purmerweg 1 NL - 1311 XE Almere

P.O. Box 60001 NL - 1320 AA Almere

The Netherlands

www.tunturi-fitness.com

info@tunturi-fitness.com



Parts list



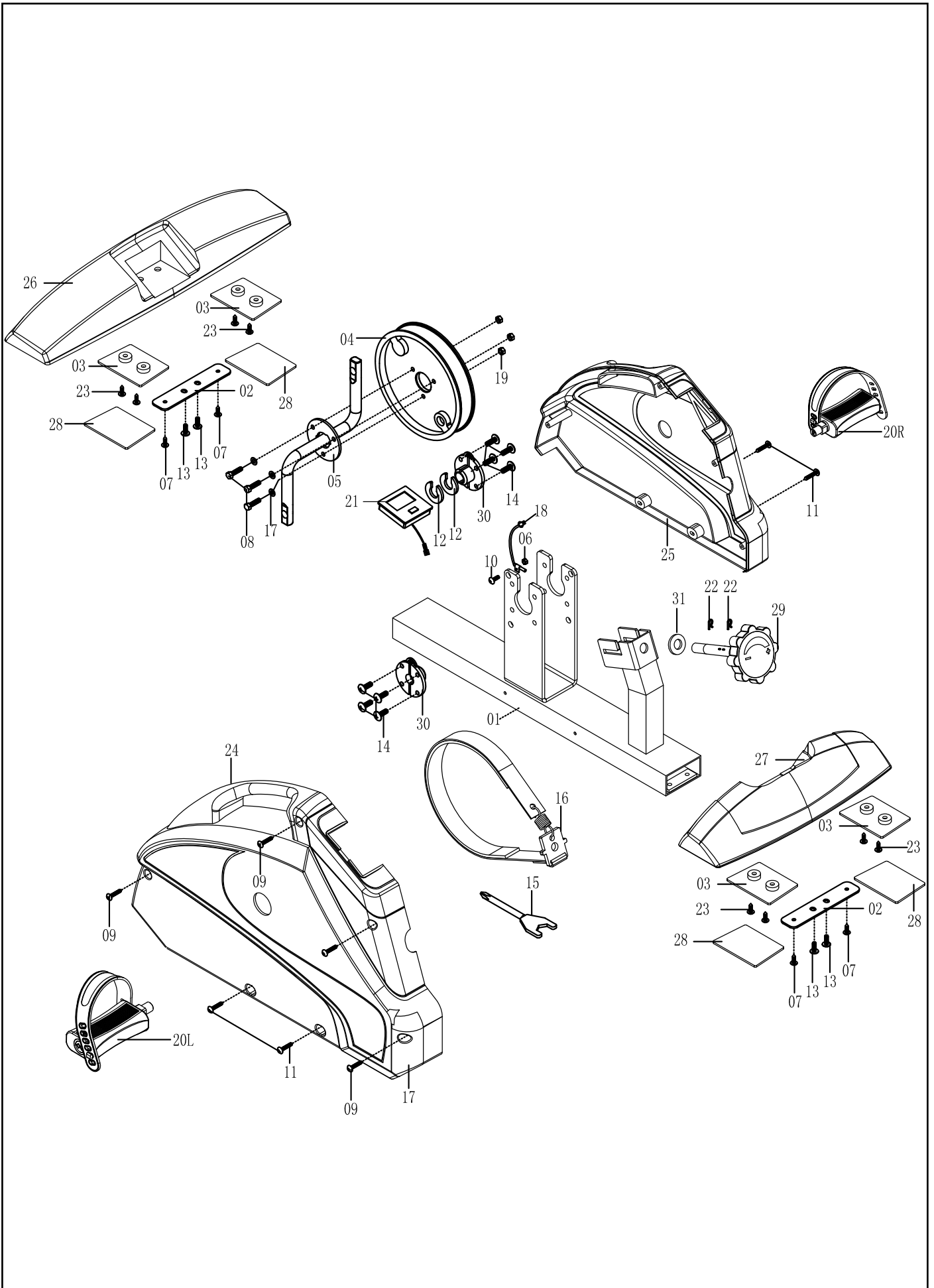













Buble	#	Description	Specification	Part number	Qty
1		Main frame			1 PCS
2		Stabilizer plate			2 PCS
3		Square plate			4 PCS
4		Flywheel			1 PCS
5		Crank			1 PCS
6		Nut	M4x4t		1 PCS
7		Self-tapping screw	ST4.2x15L		4 PCS
8		Hex head blot	M6x20L		3 PCS
9		Self-tapping screw	M4x20L		4 PCS
10		Screw	M4x10L		1 PCS
11		Self-tapping screw	M4x25L		4 PCS
12		Curved washer			2 PCS
13		Screw	M5x15L		4 PCS
14		Screw	M6x10L		8 PCS
15		Multi-function wrench			1 PCS
16		Ribbon			1 PCS
17		Flat washer	OD13 ID6.5x1.5T		3 PCS
18		Sensor wire			1 PCS
19		Domed nut	M6		3 PCS
20L		Pedal (L)		.363.5009	1 PCS
20R		Pedal (R)		.363.5010	1 PCS
21		Computer		.233.0077	1 PCS
22		Snap pin			2 PCS
23		Self-tapping screw	ST4.2x12L		8 PCS
24		Chain cover (L)			1 PCS
25		Chain cover (R)			1 PCS
26		Front stabilizer			1 PCS
27		Rear stabilizer			1 PCS
28		Non-slip pad		.533.0118	4 PCS
29		Club knob			1 PCS
30		Crank buckle			2 PCS
31		Flat washer	OD20xID10.5x1.5T		1 PCS
					PCS
HW		hardware kit		.559.7007	1 PCS



Additional service document information				
File version information			Document symbol explanation	
Gen.	1st. serial number known	latest serial number	~	up untill part ...
1	17G5AFN0001	XXX	!	Corrected items
			&	Comes with an other part in list
			≠	DIN / ISO articles are not available as spare part
			*	Included in hardware kit

Generation 1

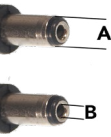
Version 1.0 First production version.

Power plug and socket type information							
	Power plug Type A		Power plug Type F		Power plug Type K		Power socket Type C7
	Power plug Type B		Power plug Type G		Power plug Type L		Power socket Type C13
	Power plug Type C		Power plug Type H		Power plug Type M		Power socket Type C19
	Power plug Type D		Power plug Type I		Power plug Type N	 DC wire plug Type define: C: A=5.5 x B=2.5mm D: A=5.5 x B=2.1mm	
	Power plug Type E		Power plug Type J				NOTE: Tunturi uses D type DC connectors only since 2006