

Platinum[®] PRO

User interface

Platinum sprinter bike



INDEX

SAFETY INSTRUCTIONS	01
GENERAL	01
Console battery installation	02
Transmitter battery installation	02
Synchronize transmitter	02
INSTALLING THE MONITOR	03
Console installation	03
Installing speed transmitter	03
DISPLAY	03
Time.....	03
RPM/ Cadence	03
Distance.	04
Kcal.....	04
Heart rate	04
DISPLAY FUNCTIONS	04
Quick start	04
Mode select	04
Reset/ heart rate alarm select	05
Time of day	05
Setting workout time	05
Heart rate target zones	06
Personal data setting	06
TROUBLE SHOOTING	07
No display on console	07
No heart rate signal	07
RPM jumps high/ low	07
Heart rate signal instabile	07
HOW TO PREPARE 2011 BIKE	08

SAFETY INSTRUCTIONS

Warning:

Before beginning this or any other exercise program, consult a physician. The physician can help you better determine what activity's or programs are most suited for you. If at any time during the workout you feel faint, or chest pain, or sever shortness of breath, stop exercising immediately and consult a physician.

General

Tunturi Platinum sprinter bike console carton consists of a computer console, speed sensor transmitter and assembly hardware. The transmitter counts the number of times the magnet, which is mounted on the flywheel assembly, passes the sensor.

The speed sensor transmitter will then send a coded signal to the console which contains the measured value (Speed and Cadence).

Both the computer console and the speed sensor transmitter use AAA type batteries.

Please install the supplied AAA batteries in the computer console and speed sensor transmitter before using.

Console Battery Installation:

1. Remove the battery cover from the back of the computer.
2. Insert 2 AAA batteries into the battery compartment and reinstall the battery cover.
3. When Battery working voltage is too low, The "Low battery" indicator will show up on the console display indicating it is time to change the batteries.

Transmitter Battery Installation:

1. Remove the battery cover from the transmitter.
2. Install 2 AAA batteries in the battery compartment and reinstall the battery cover.
3. When new batteries are installed in the transmitter or console you must perform the synchronizing procedure below for the console to work properly

Synchronizing the transmitter:

After installing the batteries, and before attaching the console and transmitter to the bike, you must synchronize the two so they can 'talk' to each other.

1. Press and hold the two keys on the front of the console for about 3 seconds until the display shows " ID - - "
2. Now press and hold the blue button on the transmitter for 3 seconds and release. The console display should show ID 0.

NOTE: You must press the blue button within 10 seconds after the console is showing ID - - otherwise the console will show: ID ER. If the console shows this error then restart the procedure again.

3. It may be necessary to remove and re-install the batteries in both the console and transmitter if you continue to receive an error.

Installation the monitor

Console Installation:

1. Install the mounting clamp (2) to the back of the console (1) with the clamp mounting screw (3).
2. Install and slightly tighten the thumb screw (4) then adjust the console angle for optimal visibility. Once the console is adjusted, continue to tighten the screw until it is securely attached to the handle bar.

Installing the speed transmitter:

1. Plug the speed sensor wire into the transmitter (6)
2. Attach the transmitter (with Velcro pre-attached to the back) to the Velcro half that is pre-installed to the bike frame. The Velcro is mounted to the back side of the chain cover, below the left crank

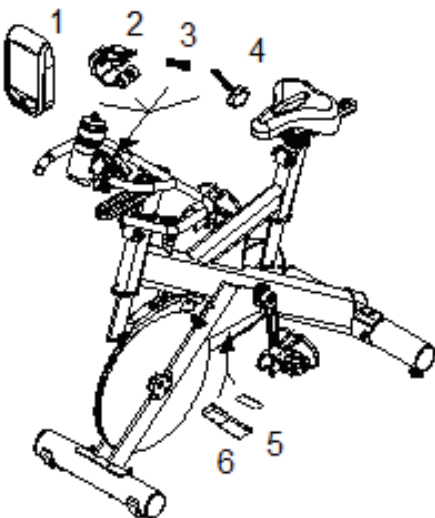

1. Console
2. Mounting clamp
3. Clamp mounting screw
4. Clamp thumb screw
5. Velcro
6. Speed transmitter

Display

Display window

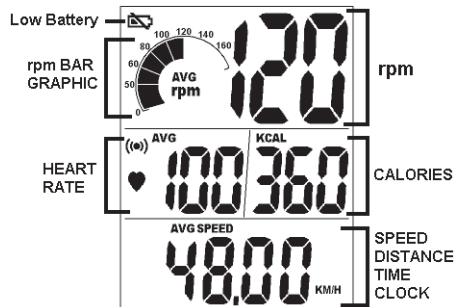

TIME

Time is measured in min:sec
 There is a time of day clock and a workout timer clock.
 The workout time will count up or count down during pedaling. If pedaling stops, the time will stop counting after 3sec.

RPM/CADENCE

Cadence is the measurement of how fast the cranks are rotating in RPM. The approximate speed of the bike can also be display in MPH or KPH. In addition to the MPH/KPH, the RPM section of the display also has a bar graph that allows the rider to visually keep track of the approximate RPM.

DISTANCE

Distance is the measurement of the virtual distance traveled on the bike. This distance is based on the user riding a bike with tires that are the same size as the group bike's flywheel.

KCAL

Kcal is the approximation of calories burned during your work out. The calories are an estimate only.

HEART RATE

This the approximation of heart rate detected from the chest belt during your work out.

Display functions

QUICK START

When the console is in Power Saving Mode, hold down any key to wake up the console and go to the start-up screen, also called "QUICK Start" active state.

QUICK START Mode

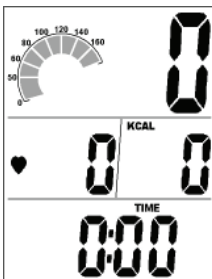

MODE SELECT

Press the left hand key to select the SPEED, DIST, TIME or CLOCK at the bottom of the display.

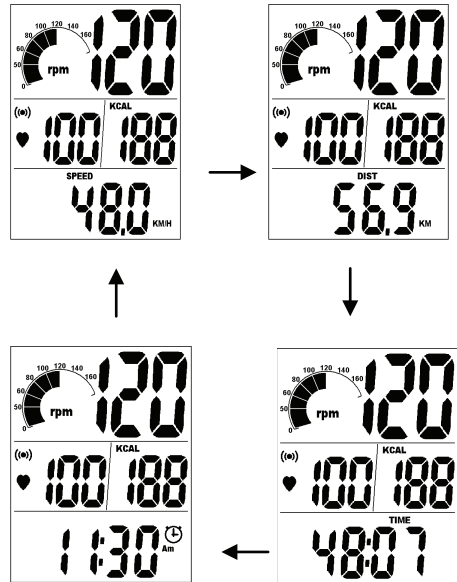

RESET/HEART RATE ALARM SELECT

1. Press the right hand key to activate the heart rate alarm. If the alarm is on, the alarm icon will flash and a beep will sound to indicate that your heart rate is either above or below the selected target zone.
1. RESET: Press and hold the left hand key for 3 seconds. All the accumulated values for AVG SPEED, AVG PULSE, TIME, DIST, KCAL will return to zero.

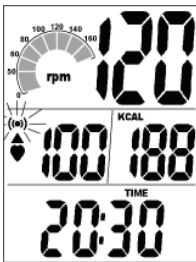

TIME OF DAY

1. If you want to change the time of day settings at any time press the left hand key until time of day is displayed then press the right hand key for 3 seconds. The display will flash an indication of whether the clock is set for 12H clock or 24H military time clock. Press the right hand key to change.
2. Press the left hand key to switch to the hour setting, use the right hand key to change hours.

3. Press the left hand key again to switch to minutes and use the right hand key to change the minutes.
4. When you are finished, wait a few seconds for the display to return to the start-up screen.

SETTING WORKOUT TIME

1. Press and hold the right hand key when the bottom section of the display is showing SPEED; the Minutes will now be flashing. Press the right hand key to increase Minutes setting.
2. To clear the exercise Time press the left hand key until the time is displayed then hold the right hand key for three seconds.

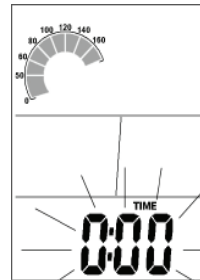

HEART RATE TARGET ZONES

Press the left hand key until 'SPEED' is displayed then hold the right hand key for 3 seconds. The TIME will be flashing; press the left hand key to select the heart rate target zone settings.

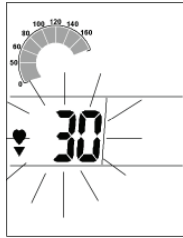

Press the right hand key to increase maximum heart rate limit. After setting the maximum heart rate, press the left hand key to adjust the minimum heart rate limit.

PERSONAL DATA SETTING

1. GENDER: Press the left hand key until SPEED is displayed then, press the right hand key for 3 seconds. The TIME will be flashing, press the left hand key until the gender icon is blinking. Press the right hand key to select the gender.
2. UNITS: Press the left hand key to set the measuring value for weight (Lb or Kg), press the right hand key to select.

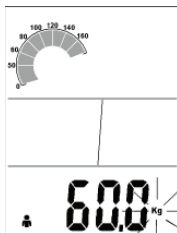
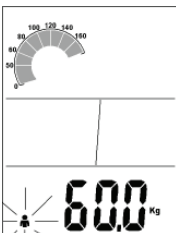

BODYWEIGHT: Press the left hand key to set the bodyweight, press the right hand key to increase the weight. Press and hold the right hand key for rapid advance.

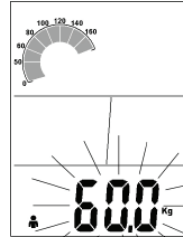

TROUBLESHOOTING

No Display on Console

1. Hold down any key to bring the console to "Quick Start" mode.
2. Ensure that the batteries are installed properly in the console and transmitter. If they are, install fresh batteries.

No Heart Rate signal displayed

1. Ensure that your chest strap is worn correctly and that there is no moisture under the electrodes.
2. Relocate the bike away from any equipment that could potentially interrupt the radio frequency signal, such as a DVD player or television, etc.

RPM jumps high or low

1. Separate bikes that may be set to the same console code and are cross-talking, or re-synchronize the transmitter and console (see page 5).
2. Relocate the bike to a different part of the room, away from any RF interference areas.

Heart Rate signal unstable

1. Ensure that there is a minimum distance of 36 inches between bikes.
2. Verify that your chest strap is secure and that the electrodes are making contact with your chest at all times.

CAUTION

EXTERNAL INTERFERENCE MAY BE CAUSED BY OTHER ELECTRONIC DEVICES, SUCH AS: NEARBY TELEVISIONS, STEREO EQUIPMENT, SPEAKERS, ELECTRICAL WIRE CABLING, ETC. IF YOU EXPERIENCE DISTURBANCES IN THE CONSOLE DISPLAY TRY MOVING YOUR BIKE(S) AWAY FROM POTENTIAL RF INTERFERENCE AREAS.

Notice of FCC Compliance

This equipment has been tested and found to comply with the limits for a Class C Low Power Communication Device Transmitter, pursuant to Part 15 of the FCC rules. Operation is subject to the following conditions:

(1) This device may not cause harmful interference, and (2) this device must accept any interference received, including interference that may cause undesired operation.

There is no guarantee that interference will not occur in a particular installation. If this equipment experiences interference from a radio, television, or other RF signal, the user is encouraged to try and correct the interference by increasing the separation between the equipment and the apparatus emitting the interfering RF signal.

How to repair 2010 models for display



The first collection Platinum sprinter bikes was not yet equipped with a magnet for speed reading. This needs to be fitted to make the sensor pick up your revolution speed. When ordering for a user interface kit for your first collection Platinum sprinter bike this comes included.

1. Fit the magnet in the magnet socket on the flywheel



2. fit the sensor bracket to the chain cover in a position where the magnet passes for speed pickup. put the sensor in the holder.



3. Place the sensor transmitter in a position where the pedals can not catch the wires. (we suggest to use the gap in the chain cover)

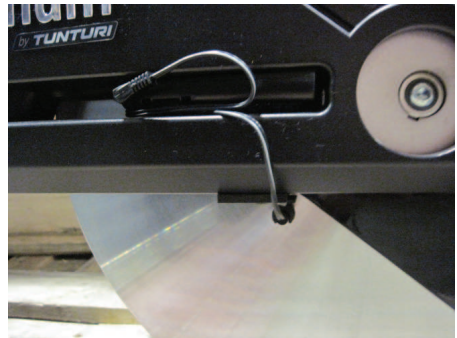

Tunturi Fitness B.V.
P.O. Box 60001
1320 AA
The Netherlands

www.tunturi.com

Version: 20140519